



This manual covers the following Selec PLC product series.
MM3030, MM3032, MM3050

SAFETY PRECAUTIONS

This manual is meant for person involved in wiring, installation, operation and routine maintenance of the equipment. All safety related codifications, symbols and instructions that appear in this operating manual or on the equipment must be strictly followed to ensure operator and instrument safety. Any misuse may impair the protection provided by the equipment.

CAUTION: Read complete instructions prior to installation and operation of the unit.

CAUTION: Risk of electric shock.

INSTALLATION INSTRUCTIONS

CAUTION

- This equipment, being built-in-type, normally becomes a part of the main control panel and the terminals do not remain accessible to the user after installation.
- Conductors must not come in contact with the internal circuitry of the equipment else it may lead to a safety hazard that may endanger life or cause electrical shock to the operator.
- Circuit breaker or mains switch must be installed between the power source and supply terminals to facilitate power 'ON' or 'OFF' function.
- The equipment shall not be installed in environmental conditions other than those specified in this manual.
- Since this equipment forms part of the main control panel, its output terminals get connected to the host equipment. Such equipment shall also comply to EMI/EMC and safety requirements like BS EN 613261 and BS EN 61010.
- Thermal dissipation of equipment is met through ventilation holes provided on housing of equipment. Obstruction of these ventilation holes may lead to a safety hazard.
- The output terminals shall be loaded strictly as per the values/range specified by the manufacturer.

ELECTRICAL PRECAUTIONS DURING USE

Electrical noise generated by switching of inductive loads can create momentary disruption, erratic display, latch up, data loss or permanent damage to the instrument.

To reduce noise:

A) Use of MOV / Snubber circuit across load / Contactors of the unit and snubber circuits across the load are recommended.

- MOV Part no.: AP-MOV-03
- Snubber Part no.: APRC-01.

CAUTION

Note: Diagram shown below is applicable only for PLC's With Relay Outputs.

TYPICAL CONNECTIONS FOR LOADS :

For load current < 0.5A

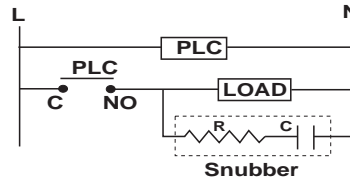

For bigger loads use interposing relay/contactor

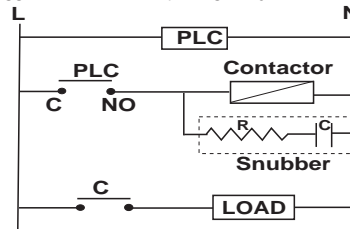

NOTE: Use snubber as shown above to increase life of internal relay.

B) Use separate shielded wires for inputs.

MECHANICAL INSTALLATION

Outline dimensions (in mm)

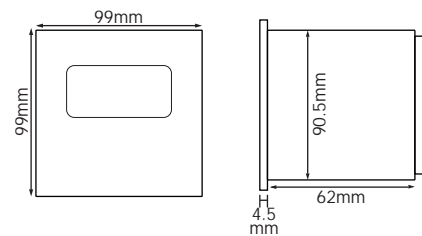

Panel Cutout (in mm)

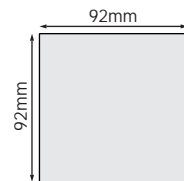

For installing the controller

- Prepare the panel cutout with proper dimensions as shown above.
- Remove the clamp from the PLC.
- Fix the unit into the cutout. Insert the clamp from both sides and tighten the screws.

CAUTION

The equipment in its installed state must not come in close proximity to any heating sources, caustic vapors, oils, steam, or other unwanted process byproducts.

EMC Guidelines:

- Use proper input power cables with shortest connections and twisted type.
- Layout of connecting cables shall be away from any internal EMI source.

MAINTENANCE

- To avoid blockage of ventilation holes, clean the equipment regularly using a soft cloth.
- Do not use Isopropyl alcohol or any other organic solvents for cleaning.

WIRING INSTRUCTIONS

CAUTION

- To prevent risk of electric shock, power supply to the equipment must be kept OFF while wiring.
- Terminals and electrically charged parts must not be touched when the power is ON.
- Wiring shall be done strictly according to the terminal layout provided in the operating manual.
- To eliminate electromagnetic interference use short wire with adequate ratings and twists of equal size.
- The power supply connection cable must have a cross section of 1sq.mm or greater and insulation capacity of atleast 1.5KV.

MOUNTING

A) PANEL MOUNTING

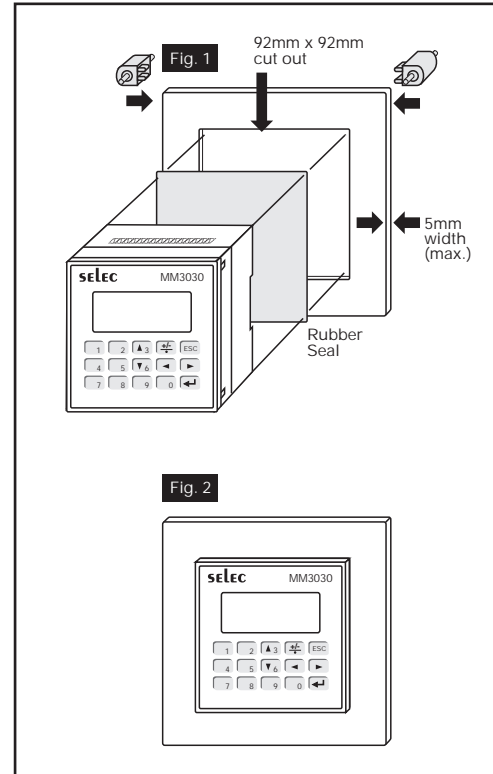

- Before you begin, note that the mounting panel cannot be thicker than 5 mm (0.197").
- Make a panel cut-out measuring 92mm x 92mm (3.622" x 3.622").
- Slide the controller into the cut-out, ensuring that the rubber seal is in place.
- Push the 2 mounting brackets into their slots on the sides of the controller as shown in Fig. 1.
- Tighten the bracket screws against the panel. Hold the bracket securely against the unit while tightening the screw.
- When properly mounted, the controller is squarely situated in the panel cut out as shown in Fig. 2.

B) DIN RAIL MOUNTING

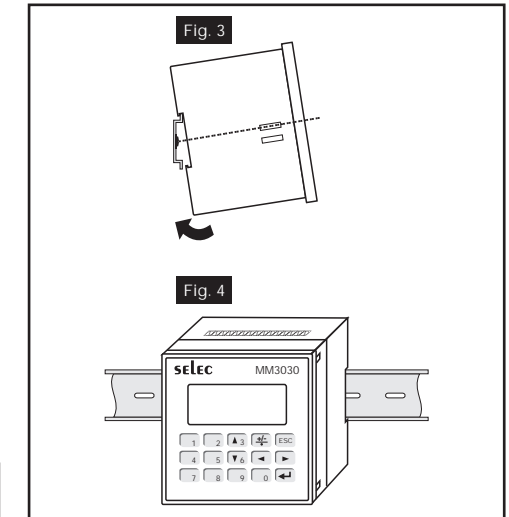

- Snap the controller onto the DIN rail as shown in Fig. 3 above.
- When properly mounted, the controller is squarely situated on the DIN-rail as shown in Fig. 4 above.

COMMUNICATION

While making communication connections, make sure that the power supply to the unit is OFF.

MM303X series product have possibility of 2 communication ports please refer data sheets of individual products for supporting ports.

Port 1 - RS232

Port 2 - IO Expansion (I0610 / I0630 series)

Port 1 - Purpose & Scope

Purpose	Protocol	Physical medium	Connecting Nodes
Downloading	MODBUS	RS232	PC to PLC
Uploading	MODBUS	RS232	PLC to PC
Online Simulation	MODBUS Slave	RS232	PLC to PC
As a slave in RS485 network	MODBUS Slave	RS485	PLC in RS485 network

Continue

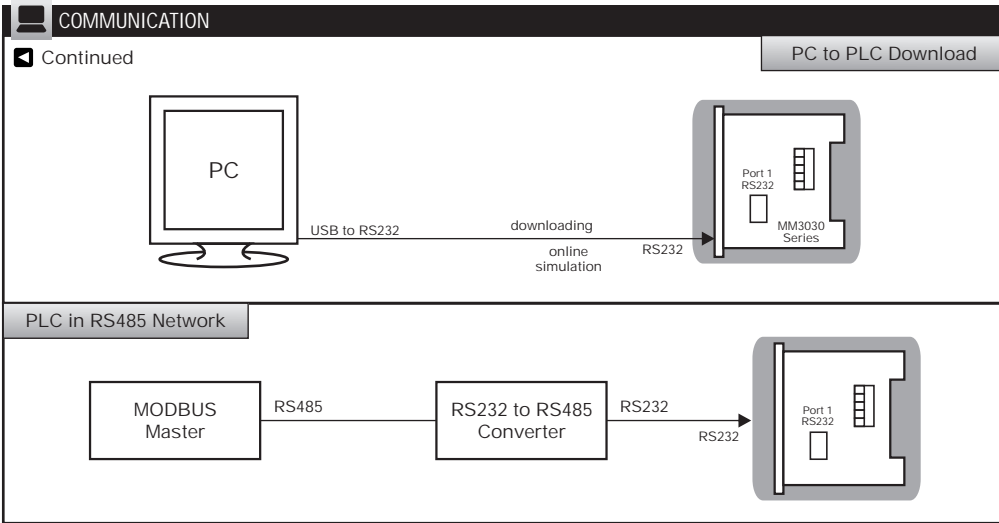

Port 2 - Purpose & Scope

Purpose	Protocol	Medium	Supporting PLC Model
IO610 Expansion Module	MODBUS	RS485	MM3030-2
RS485 Network	MODBUS	RS485	MM3030-2
IO Expansion	Proprietary	Dedicated	MM3030-1 / MM3030-3 / MM3050

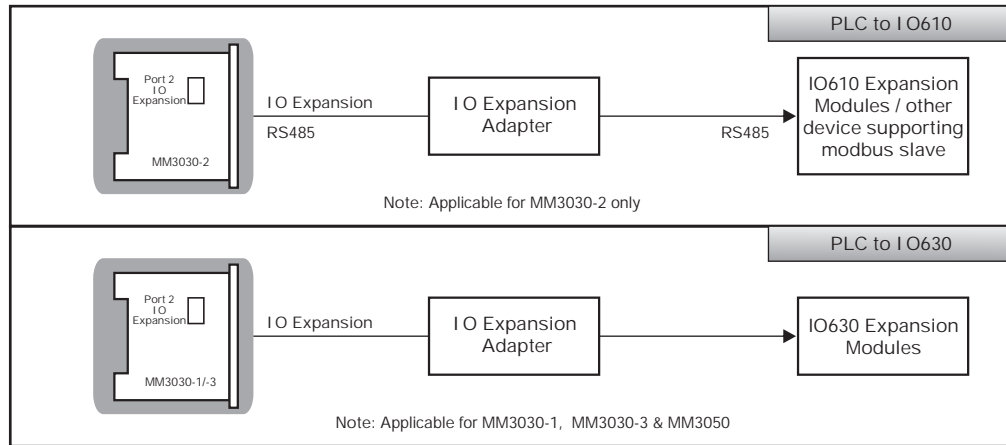

Note: Upto 31 (Slave ID 1 to 31) expansion modules can be connected in network.

? SERVICE DETAILS

This device contains no user serviceable parts and requires special equipment and specialized engineers for repair.

Please contact service center for repair on the following numbers:

Toll free: 1800 227353 (BSNL/MTNL subscribers only)
Others: 91-22-40394200 / 40394202

NO WARRANTY ON UNIT DAMAGED DUE TO WRONG POWER SUPPLY.

TO ORDER

Toll free: 1800 227 353
Phone: 91-22-28471 1882 / 4039 4200 / 4039 4202
Email: sales@selec.com
Fax: 91-22-2847 1733

ORDERING INFORMATION

ACCESSORIES (to be ordered separately)

Communication cable:
Part no. - ACH - 002.

Windows-based software for ladder programming:
Part no. - ACD-003

Relay module:
Part no. -
1) AR - S8 - 24V - 1CO (1 Change over)
2) AR - S8 - 24V - 2CO (2 Change over)

Power Supply module:
Part No:
1) PS - CF - 24V - 1.1A
2) PS - CF - 24V - 2.5A

IO Expansion Cable:
Part No: ACH-003

IO Expansion Adapter
Part No:- AC-IOEXP-01

IO610 Expansion Modules

- IO610-8DI (8 Digital inputs)
- IO610-4RO (4 Relay Outputs)
- IO610-4TO (4 Transistor Outputs)
- IO610-2AI-VI (2 Analog inputs (Voltage / Current))
- IO610-2AI-TCR (2 Analog inputs (TC/RTD))
- IO610-2AO (2 Analog Outputs)

IO630 Expansion Modules

- IO630-8DI (8 Digital inputs)
- IO630-4RO (4 Relay Outputs)
- IO630-4TO (4 Transistor Outputs)
- IO630-2AI-VI (2 Analog inputs (Voltage / Current))
- IO630-2AI-TCR (2 Analog inputs (TC/RTD))
- IO630-2AO (2 Analog Outputs)

Selec Controls Pvt. Ltd.

Specifications are subject to change, since development is a continuous process

Telephone: +91-22-40394200 / 40394202
Fax: +91-22-28471733
Toll free: 1800 227 353
Website: www.selec.com
Email: sales@selec.com



FEATURES

Compact PLC with built-in HMI.
4 line x 16 character LCD display.
User friendly Windows based software for ladder programming and HMI configuration
Special port for IO expansion.
Battery back up and RTC available

SPECIFICATIONS	
Display	LCD (backlight) 4 line x 16 character, Font size 5 x 7
Supply Voltage	20-30V DC (Minimum 1.1A SMPS recommended)
No. of Keys	15 (10 numeric keys)
No. of Configurable Keys	12

INPUT SECTION																
Inputs	10 inputs															
Input Type	I0 to I9 - PNP															
Input Voltage	11-30 V DC															
Response Time	Programmable from 1 to 255ms from Front End (Default 10ms)(Also depends on ladder execution time)															
Isolation	2kV															
No. of fast Input Channels	3 inputs A) FC0 - I0 & I1 - Rate / Totalizer B) FC1 - I2 & I3 - Rate / Totalizer C) FC2 - I4 & I5 - Totalizer															
Operating Modes	Unidirectional / Bidirectional / Quadrature Modes															
Max Speed.	<table border="1"> <thead> <tr> <th>Input no</th> <th>Operating Mode</th> <th>Frequency</th> </tr> </thead> <tbody> <tr> <td>I0, I1</td> <td>Uni / Bi</td> <td>25KHz</td> </tr> <tr> <td>I0, I1</td> <td>Quad</td> <td>10KHz</td> </tr> <tr> <td>I2, I3</td> <td>Uni / Bi / Quad</td> <td>10KHz</td> </tr> <tr> <td>I4, I5</td> <td>Uni / Bi / Quad</td> <td>10KHz</td> </tr> </tbody> </table>	Input no	Operating Mode	Frequency	I0, I1	Uni / Bi	25KHz	I0, I1	Quad	10KHz	I2, I3	Uni / Bi / Quad	10KHz	I4, I5	Uni / Bi / Quad	10KHz
	Input no	Operating Mode	Frequency													
	I0, I1	Uni / Bi	25KHz													
	I0, I1	Quad	10KHz													
I2, I3	Uni / Bi / Quad	10KHz														
I4, I5	Uni / Bi / Quad	10KHz														
Minimum Rate Measured	0.06Hz															
Maximum Count	32 bits															

ANALOG SECTION	
Input	2 input (AI 0, AI 1)
Analog Sensor	Voltage (0-10V), Current (0-20mA) (Selectable via jumper)
Resolution	10 bit
Accuracy	1 bit
Linearity	0.1 %

OUTPUT SECTION	
Digital Outputs	8 (Transistorized)
Output Type	O0 & O1 - NPN @24V DC 50 mA, O2 - O7 PNP @24V DC 100 mA.
Isolation	2kV
Short Circuit Protection	Yes
Min. Switching Time	1ms (Also depends on Ladder scan time)
PWM Output	2 Channels @ O0 & O1,Pulse width: multiples of 1 ms, Duty Cycle: 0.1% Least Count
Pulse Output	2 Channels @ O0 & O1 50 Khz -programming On & Off timers in 1 us resolution, Programmable no of pulses.

FUNCTIONAL SPECIFICATIONS	
Programming Method	Windows based software for ladder programming and HMI Configuration.
Memory	Data Memory: 16k, Code Memory: 351k, Upload Memory: 96 k
No. of Objects	Maximum 5000 (As per memory)
Minimum Scan Time	200 µsec
Typical Scan Time	1 ms (Also depends on ladder programming)

FUNCTIONAL BLOCKS	
Timer	On Delay Timer, Off Delay Timer, Up Timer / Down Timer (Special Timer). 1ms Timer & Pulse Timer
Counter	Up Counter, Down Counter & Up/Down Counter (With & without over run)
Other Blocks	PID Control with auto tune, Totalizer, Rate totalizer, PWM Output,Pulse output, Time Switch, Hysteresis & Scaling.
Memory Retention	10 years (4 Kb)
RTC	Yes
Communication Ports	RS232 (Slave), I/O Expansion port
Communication Protocols	Modbus RTU: RS232, Proprietary Protocol: I/O Expansion Port
Supported Expansion Series	IO630 Expansion modules
Temperature range	Operating : 0 to 50°C, Storage : -20 to 60°C
Humidity	95% RH (Non Condensing)
Weight	348 gms
Order Code	MM3030-1

MECHANICAL SPECIFICATION	
Mounting	Panel mounting & Din rail Mounting
Front Bezel / Side View	99 X 99 mm / 62 X 90.5 mm
Panel Cutout	92 X 92 mm
Din Rail	35 mm

? SERVICE DETAILS

This device contains no user serviceable parts and requires special equipment and specialized engineers for repair. Please contact service center for repair on the following numbers:
Toll free: 1800 227353 (BSNL/MTNL subscribers only)
Others: 91-22-40394200 / 40394202

NO WARRANTY ON UNIT DAMAGED DUE TO WRONG POWER SUPPLY.



TERMINAL CONNECTIONS

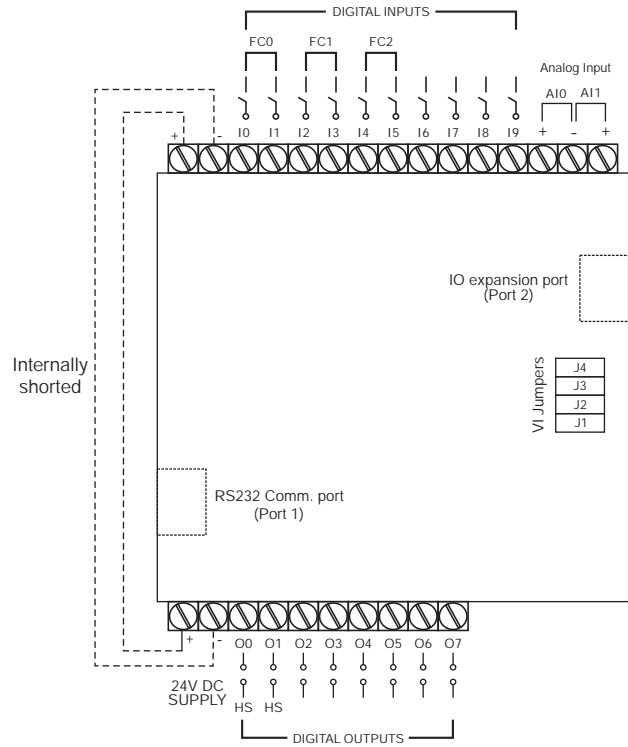

PIN Configuration
 MM3030-1 has two ports
 Port 1- 6 Pin Jack (RS 232)
 Port 2- 8 Pin Jack (IO Expansion)

**Port 1
RS232**

PIN	DESCRIPTION
1	NC
2	GND
3	TXD (RS 232)
4	RXD (RS 232)
5	GND
6	NC

**Port 2
IO Expansion**

PIN	DESCRIPTION
1	NC
2	NC
3	GND
4	IO +ve
5	IO -ve
6	GND
7	NC
8	NC

**Jumper settings for Voltage & Current selection
for Analog channels**

Sr. No.	Jumper No	Description
1	J4	For Current Channel 1
2	J3	For Voltage Channel 1
3	J2	For Current Channel 0
4	J1	For Voltage Channel 0

CAUTION

Please ensure jumper settings as J1 & J3 are selected before applying 10 VDC to Analog channels. Ignoring this directive may damage Analog channels

Selec Controls Pvt. Ltd.

Specifications are subject to change, since development is a continuous process.

Telephone: +91-22-40394200 / 40394202
 Fax: +91-22-28471733
 Toll free: 1800 227 353
 Website: www.selec.com
 Email: sales@selec.com



FEATURES

Compact PLC with built-in HMI.
4 line x 16 character LCD display.
User friendly Windows based software for ladder programming and HMI configuration
Special port for IO expansion.
Battery back up and RTC available

SPECIFICATIONS	
Display	LCD (backlight) 4 line x 16 character, Font size 5 x 7
Supply Voltage	20-30V DC (Minimum 1.1A SMPS recommended)
No. of Keys	15 (10 numeric keys)
No. of Configurable Keys	12

INPUT SECTION																
Inputs	10 inputs															
Input Type	I0 to I9 - PNP															
Input Voltage	11-30 V DC															
Response Time	Programmable from 1 to 255ms from Front End (Default 10ms)(Also depends on ladder execution time)															
Isolation	2kV															
No. of fast Input Channels	3 inputs A) FC0 - I0 & I1 - Rate / Totalizer B) FC1 - I2 & I3 - Rate / Totalizer C) FC2 - I4 & I5 - Totalizer															
Operating Modes	Unidirectional / Bidirectional / Quadrature Modes															
Max Speed.	<table border="1"> <thead> <tr> <th>Input no</th> <th>Operating Mode</th> <th>Frequency</th> </tr> </thead> <tbody> <tr> <td>I0, I1</td> <td>Uni / Bi</td> <td>25KHz</td> </tr> <tr> <td>I0, I1</td> <td>Quad</td> <td>10KHz</td> </tr> <tr> <td>I2, I3</td> <td>Uni / Bi / Quad</td> <td>10KHz</td> </tr> <tr> <td>I4, I5</td> <td>Uni / Bi / Quad</td> <td>10KHz</td> </tr> </tbody> </table>	Input no	Operating Mode	Frequency	I0, I1	Uni / Bi	25KHz	I0, I1	Quad	10KHz	I2, I3	Uni / Bi / Quad	10KHz	I4, I5	Uni / Bi / Quad	10KHz
	Input no	Operating Mode	Frequency													
	I0, I1	Uni / Bi	25KHz													
	I0, I1	Quad	10KHz													
I2, I3	Uni / Bi / Quad	10KHz														
I4, I5	Uni / Bi / Quad	10KHz														
Minimum Rate Measured	0.06Hz															
Maximum Count	32 bits															

ANALOG SECTION	
Input	2 input (AI 0, AI 1)
Analog Sensor	Voltage (0-10V), Current (0-20mA)(Selectable via jumper)
Resolution	10 bit
Accuracy	1 bit
Linearity	0.1 %

OUTPUT SECTION	
Digital Outputs	8 (Transistorized)
Output Type	O0 & O1 - NPN @24V DC 50 mA, O2 - O7 PNP @24V DC 100 mA.
Isolation	2kV
Short Circuit Protection	Yes
Min. Switching Time	1ms (Also depends on Ladder scan time)
PWM Output	2 Channels @ O0 & O1,Pulse width: multiples of 1 ms, Duty Cycle: 0.1% Least Count
Pulse Output	2 Channels @ O0 & O1 50 KHz -programming On & Off timers in 1 us resolution, Programmable no of pulses.

FUNCTIONAL SPECIFICATIONS	
Programming Method	Windows based software for ladder programming and HMI Configuration.
Memory	Data Memory 16k, Code Memory : 351k, Upload Memory: 96 k
No of Objects	Maximum 5000 (As per memory)
Minimum Scan Time	200 µsec
Typical Scan Time	1 ms (Also depends on ladder programming)

FUNCTIONAL BLOCKS	
Timer	On Delay Timer, Off Delay Timer, Up Timer / Down Timer (Special Timer). 1ms Timer (max 4 blocks) & Pulse Timer
Counter	Up Counter, Down Counter & Up/Down Counter (With & without over run)
Other Blocks	PID Control with auto tune, Totalizer, Rate totalizer, PWM Output,Pulse output, Time Switch, Hysteresis & Scaling.
Memory Retention	10 years (4 Kb)
RTC	Yes
Communication Ports	RS232 (Slave), I/O Expansion port (Master)
Communication Protocols	Modbus RTU: RS232, Modbus RTU : I/O Expansion Port
Supported Expansion Series	IO610 Expansion modules
Temperature range	Operating : 0 to 50°C, Storage : -20 to 60°C
Humidity	95% RH (Non Condensing)
Weight	348 gms
Order Code	MM3030-2

MECHANICAL SPECIFICATION	
Mounting	Panel mounting & Din rail Mounting
Front Bezel / Side View	99 X 99 mm / 62 X 90.5 mm
Panel Cutout	92 X 92 mm
Din Rail	35 mm

? SERVICE DETAILS

This device contains no user serviceable parts and requires special equipment and specialized engineers for repair. Please contact service center for repair on the following numbers:
Toll free: 1800 227353 (BSNL/MTNL subscribers only)
Others: 91-22-40394200 / 40394202

NO WARRANTY ON UNIT DAMAGED DUE TO WRONG POWER SUPPLY.



TERMINAL CONNECTIONS

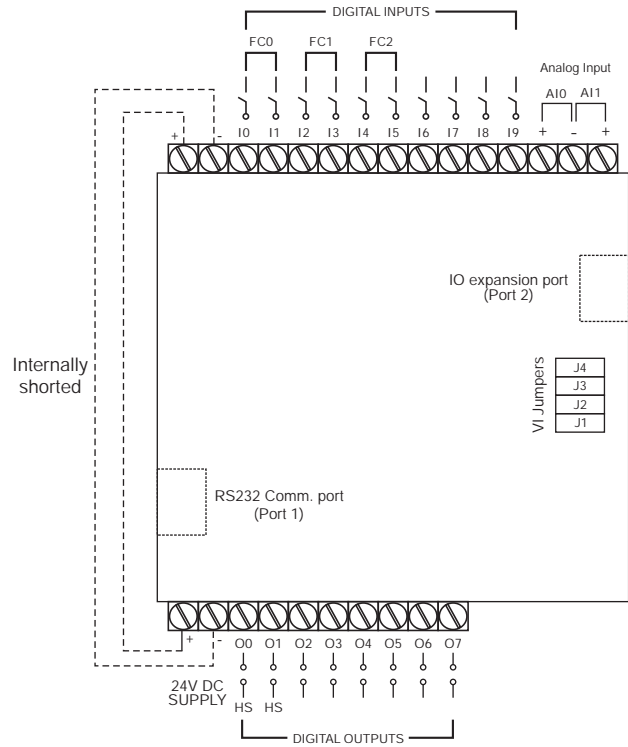

PIN Configuration
 MM3030-2 Has two ports
 Port 1- 6 Pin Jack (RS 232)
 Port 2- 8 Pin Jack (IO Expansion)

**Port 1
RS232**

PIN	DESCRIPTION
1	NC
2	GND
3	TXD (RS 232)
4	RXD (RS 232)
5	GND
6	NC

**Port 2
IO Expansion**

PIN	DESCRIPTION
1	RS485 + ve
2	RS485 - ve
3	GND
4	NC
5	NC
6	GND
7	NC
8	NC

**Jumper settings for Voltage & Current selection
for Analog channels**

Sr. No.	Jumper No	Description
1	J4	For Current Channel 1
2	J3	For Voltage Channel 1
3	J2	For Current Channel 0
4	J1	For Voltage Channel 0

CAUTION
 Please ensure jumper settings as J1 & J3 are selected before applying 10 VDC to Analog channels. Ignoring this directive may damage Analog channels

Selec Controls Pvt. Ltd.

Specifications are subject to change, since development is a continuous process.

Telephone: +91-22-40394200 / 40394202
 Fax: +91-22-28471733
 Toll free: 1800 227 353
 Website: www.selec.com
 Email: sales@selec.com



FEATURES

Compact PLC with built-in HMI.
4 line x 16 character LCD display.
User friendly Windows based software for ladder programming and HMI configuration
Special port for IO expansion.

SPECIFICATIONS	
Display	LCD (backlight) 4 line x 16 character, Font size 5 x 7
Supply Voltage	90-270 V AC
No. of Keys	15 (10 numeric keys)
No. of Configurable Keys	12

INPUT SECTION																
Inputs	8 inputs															
Input Type	I0 to I7 - PNP															
Input Voltage	11-30 V DC															
Response Time	Programmable from 1 to 255ms from Front End (Default 10ms)(Also depends on ladder execution time)															
Isolation	2kV															
No of fast Input Channels	3 inputs A) FC0 - I0 & I1 - Rate / Totalizer B) FC1 - I2 & I3 - Rate / Totalizer C) FC2 - I4 & I5 - Totalizer															
Operating Modes	Unidirectional / Bidirectional / Quadrature Modes															
Max Speed.	<table border="1"> <thead> <tr> <th>Input no</th> <th>Operating Mode</th> <th>Frequency</th> </tr> </thead> <tbody> <tr> <td>I0, I1</td> <td>Uni / Bi</td> <td>25KHz</td> </tr> <tr> <td>I0, I1</td> <td>Quad</td> <td>10KHz</td> </tr> <tr> <td>I2, I3</td> <td>Uni / Bi / Quad</td> <td>10KHz</td> </tr> <tr> <td>I4, I5</td> <td>Uni / Bi / Quad</td> <td>10KHz</td> </tr> </tbody> </table>	Input no	Operating Mode	Frequency	I0, I1	Uni / Bi	25KHz	I0, I1	Quad	10KHz	I2, I3	Uni / Bi / Quad	10KHz	I4, I5	Uni / Bi / Quad	10KHz
	Input no	Operating Mode	Frequency													
	I0, I1	Uni / Bi	25KHz													
	I0, I1	Quad	10KHz													
I2, I3	Uni / Bi / Quad	10KHz														
I4, I5	Uni / Bi / Quad	10KHz														
Minimum Rate Measured	0.06Hz															
Maximum Count	32 bits															

ANALOG SECTION	
Input	2 input (AI 0, AI 1)
Analog Sensor	Voltage (0-10V), Current (0-20mA)(Selectable via jumper)
Resolution	10 bit
Accuracy	1 bit
Linearity	0.1 %

OUTPUT SECTION	
Digital Outputs	6 (Relay)
Relay Contact Rating	3A (Resistive @ 240VAC)
Isolation	2kV

FUNCTIONAL SPECIFICATIONS	
Programming Method	Windows based software for ladder programming and HMI Configuration.
Memory	Data Memory: 16k, Code Memory: 351k, Upload Memory: 96 k
No of Objects	Maximum 5000 (As per memory)
Minimum Scan Time	200 µsec
Typical Scan Time	1 ms (Also depends on ladder programming)

FUNCTIONAL BLOCKS	
Timer	On Delay Timer, Off Delay Timer, Up Timer / Down Timer (Special Timer). 1ms timer (max 4 blocks) & Pulse Timer
Counter	Up Counter, Down Counter & Up/Down Counter (With & without over run)
Other Blocks	PID Control with auto tune, Totalizer, Rate totalizer, Time Switch, Hysteresis & Scaling.
Memory Retention	10 years (4 Kb)
RTC	NO
Communication Ports	RS232 (Slave), I/O Expansion port
Communication Protocols	Modbus RTU: RS232, Proprietary Protocol : I/O Expansion Port
Supported Expansion Series	IO630 Expansion modules
Temperature range	Operating : 0 to 50°C, Storage : -20 to 60°C
Humidity	95% RH (Non Condensing)
Weight	343 gms
Order Code	MM3030-3

MECHANICAL SPECIFICATION	
Mounting	Panel mounting & Din rail Mounting
Front Bezel / Side View	99 X 99 mm / 62 X 90.5 mm
Panel Cutout	92 X 92 mm
Din Rail	35 mm

? SERVICE DETAILS

This device contains no user serviceable parts and requires special equipment and specialized engineers for repair. Please contact service center for repair on the following numbers:
Toll free: 1800 227353 (BSNL/MTNL subscribers only)
Others: 91-22-40394200 / 40394202

NO WARRANTY ON UNIT DAMAGED DUE TO WRONG POWER SUPPLY.



TERMINAL CONNECTIONS

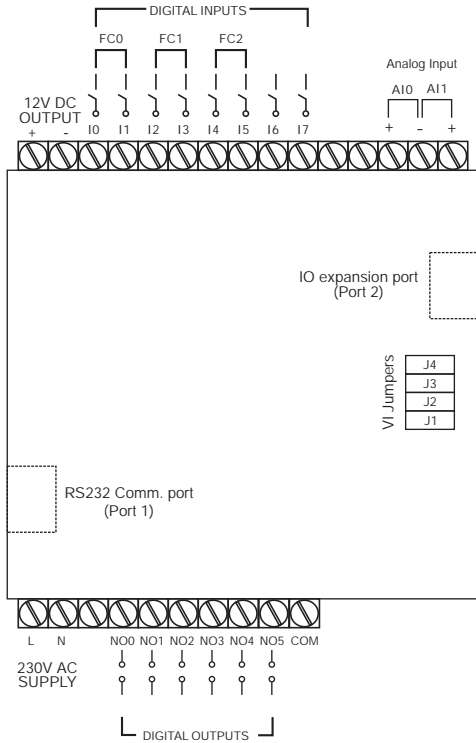

PIN Configuration
 MM3030-3 has two ports
 Port 1- 6 Pin Jack (RS 232)
 Port 2- 8 Pin Jack (IO Expansion)

Port 1
 RS232

PIN	DESCRIPTION
1	NC
2	GND
3	TXD (RS 232)
4	RXD (RS 232)
5	GND
6	NC

Port 2
 IO Expansion

PIN	DESCRIPTION
1	NC
2	NC
3	GND
4	IO + ve
5	IO - ve
6	GND
7	NC
8	NC

Jumper settings for Voltage & Current selection
 for Analog channels

Sr. No.	Jumper No	Description
1	J4	For Current Channel 1
2	J3	For Voltage Channel 1
3	J2	For Current Channel 0
4	J1	For Voltage Channel 0

CAUTION

Please ensure jumper settings as J1 & J3 are selected before applying 10 VDC to Analog channels. Ignoring this directive may damage Analog channels

Selec Controls Pvt. Ltd.

Specifications are subject to change, since development is a continuous process.

Telephone: +91-22-40394200 / 40394202
 Fax: +91-22-28471733
 Toll free: 1800 227 353
 Website: www.selec.com
 Email: sales@selec.com